



LC2327

36V/1.5A Asynchronous Buck Converter in SOT23-6

DESCRIPTION

The LC2327 is a high efficiency current-mode asynchronous, 36V/1.5A buck converter. Its input voltage ranges from 4V to 36V and it provides an adjustable regulated output voltage from 0.80V to 8V while delivering up to 0.6A of output current.

The switching frequency is set to 650KHz, which works with an inductor as small as 10uH. And the LC2327 will automatically switch between PFM and PWM mode based on the load current, thus to enhance the converter efficiency at light load.

LC2327 consists of many protection blocks such as UVLO, input voltage over voltage protection to stand much higher input voltage spike, thermal protection and output short circuit protection.

The LC2327 is available in the tiny SOT23-6 package.

FEATURES

- Adjustable Output Voltage, $V_{fb}=0.80V$
- Output current is up to 1.5A @ $V_{in}=24V$
- Range of operation input voltage: 4-36V
- Input voltage UVLO: 3.7V (voltage decreasing)
- Input Overvoltage Protection @38V
- Withstand input voltage spike >42V
- Operating current at zero load: 0.7mA (typ.)
- Line regulation: 0.1%/V (typ.)
- Load regulation: 10mV (typ.)
- High efficiency, up to 90%
- Environment Temperature: $-20^{\circ}C \sim 85^{\circ}C$

APPLICATIONS

- Power Meter
- Consumer Electronic Device for automobile
- Security camera
- Other 24V or wide range input voltage powered device

TYPICAL APPLICATION and PIN OUT

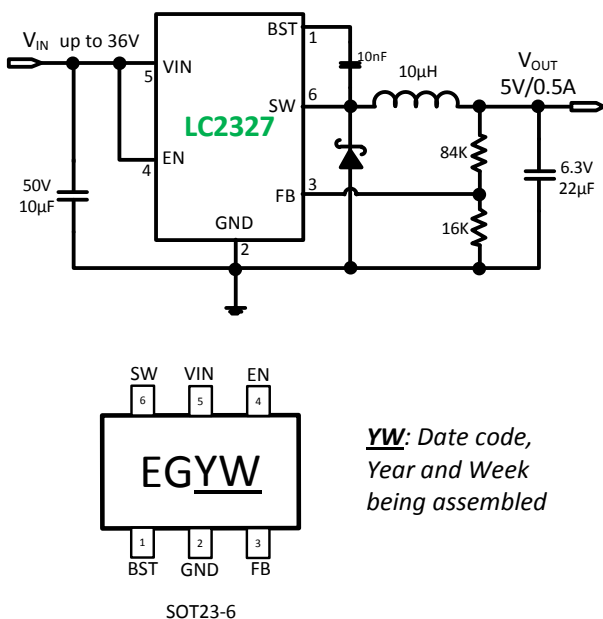

LOADING CAPABILITY

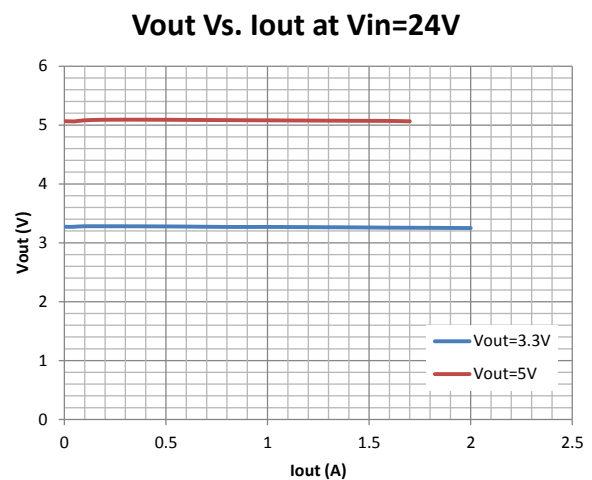

MARK and ORDERING INFORMATION

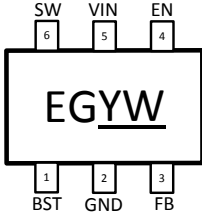
Mark Explanation		Ordering Information	
EG: Product Code YW: Date code		Product ID	LC2327CB6TR
		Devices per reel	3000

PINOUT DESCRIPTION

PIN #	NAME	DESCRIPTION
1	BST	High side power transistor gate drive boost input
2	GND	Ground.
3	FB	Feedback input with reference voltage set to 0.80V
4	EN	Enable input. Setting it to high level or connecting to Vin via a resistor may turn on the chip, while setting it to ground level will turn off the chip.
5	VIN	Power input, the input capacitor should be placed as close to VIN and GND pin as possible
6	SW	Power switching node to connect inductor

BLOCK DIAGRAM

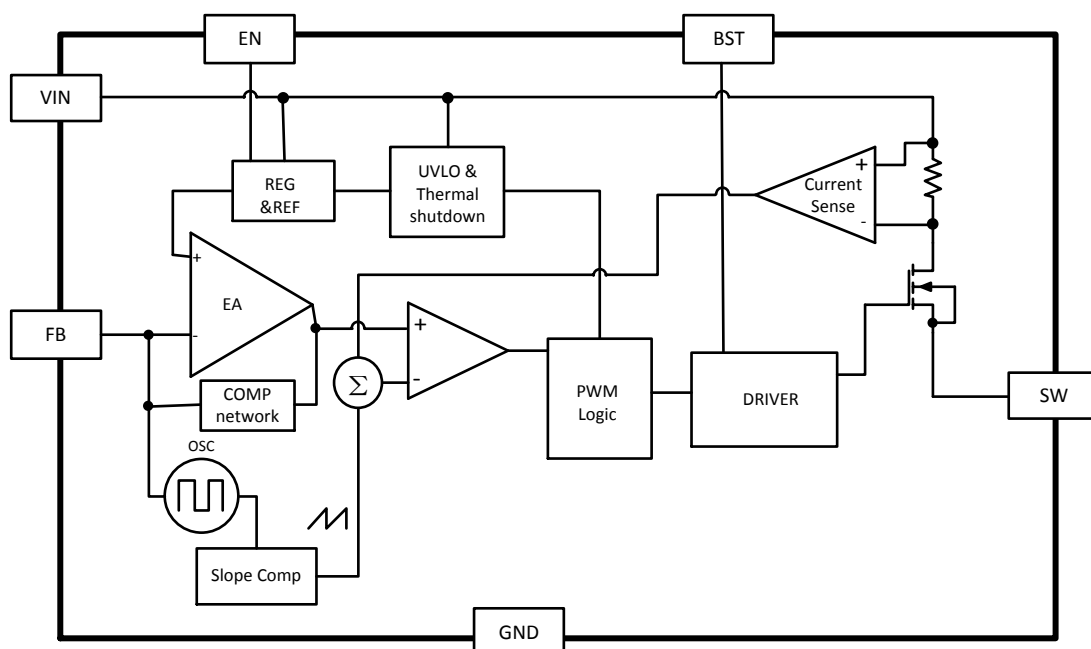

ABSOLUTE MAXIMUM RATING

Parameter		Value
Max Input Voltage		42V
Max Operating Junction Temperature(Tj)		125°C
Ambient Temperature(Ta)		-20°C – 85°C
Package Thermal Resistance	SOT23-6 (θ_{JC})	110°C / W
	SOT23-6 (θ_{JA})	220°C / W
Storage Temperature(Ts)		-40°C - 150°C
Lead Temperature & Time		260°C, 10S
ESD (HBM)		>2000V

Note: Exceed these limits to damage to the device. Exposure to absolute maximum rating conditions may affect device reliability.

RECOMMENDED WORK CONDITIONS

Parameter	Value
Input Voltage Range	6.5V - 36V
Output Voltage Range	0.8 – 8V
Operating Junction Temperature(Tj)	-20°C –125°C

ELECTRICAL CHARACTERISTICS

(VIN=12V, TA=25°C, unless specified otherwise)

Symbol	Parameter	Conditions	Min	Typ	Max	Unit
VDD	Input Voltage Range		6.5		36	V
VOUT	Output Voltage Range		0.8		8	V
Vref	Feedback Voltage	Vin=12V, Ven=5V	0.775	0.80	0.825	V
VUVLO	UVLO Voltage	Vin H->L, Iout=0.5A		6		V
I _{fb}	Feedback Leakage current			0.1	0.4	uA
I _q	Quiescent Current	Active, Vfb=1V, No Switching		0.6	1.0	mA
		Shutdown, Vin=8V		6	10	uA
LnReg	Line Regulation	Vin=5V to 12V		0.1		%/V
LdReg	Load Regulation	Iout=0.1 to 1.2A		0.02		%/A
F _{soc}	Switching Frequency	Ven=3V, Vin=12V	500	650	800	KHz
R _{dsonH}	High side Switch R _{dson}	I _{sw} =200mA		400	600	mohm
I _{limit}	Peak Inductor Current Limit	Vin=12-24V, Vout=3.3V	2	2.2		A
		Vin=12-24V, Vout=5V	1.5	1.8		A
		Vin=36V, Vout=3.3V – 5V	1.0	1.1		A
V _{enh}	EN High Threshold		0.8	1.1	1.5	V
V _{enl}	EN Low Threshold				0.5	V
V _{ovp}	Input Over-Voltage Protection	Ven=3V		38		V
TSD	Over Temperature Protection	Hysteresis=40°C		150		°C

TYPICAL PERFORMANCE CHARACTERISTICS

($V_{in}=24V$, $V_{out}=5.0V$, $L=10\mu H$, $C_{in}=10\mu F$, $C_{out}=22\mu F$, $T_A=25^\circ C$, unless otherwise stated)

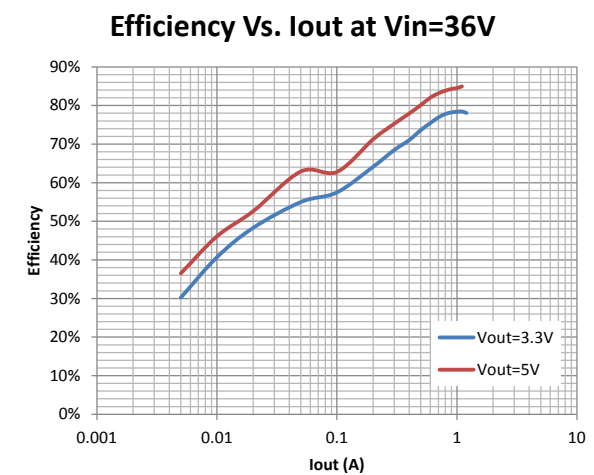
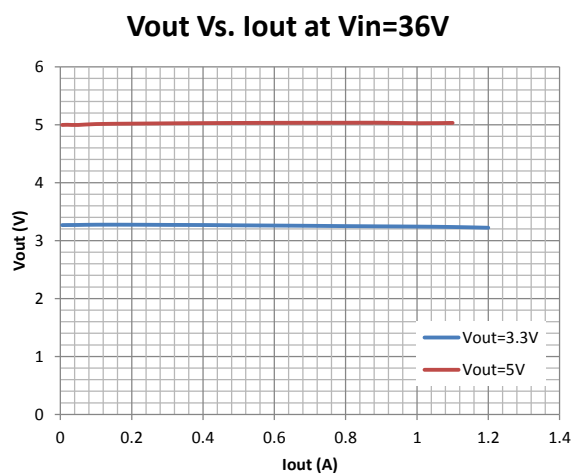
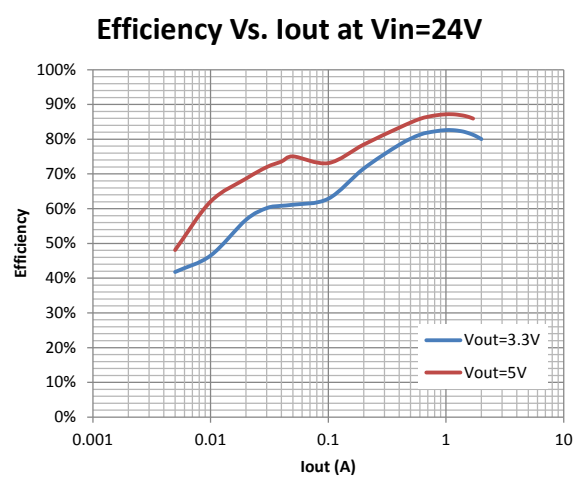
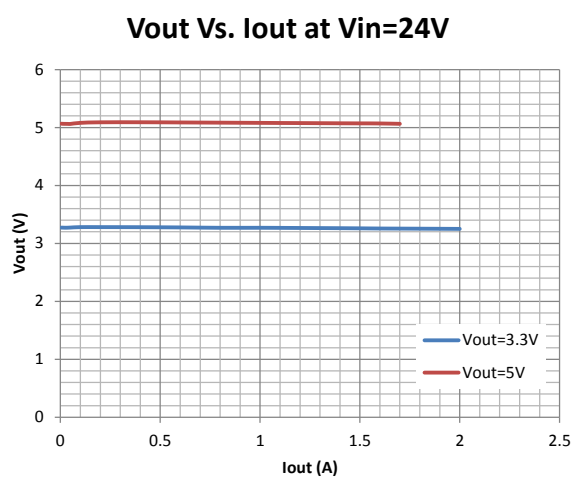
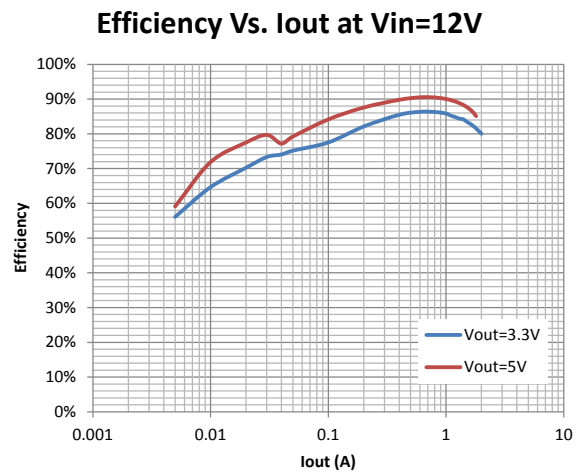
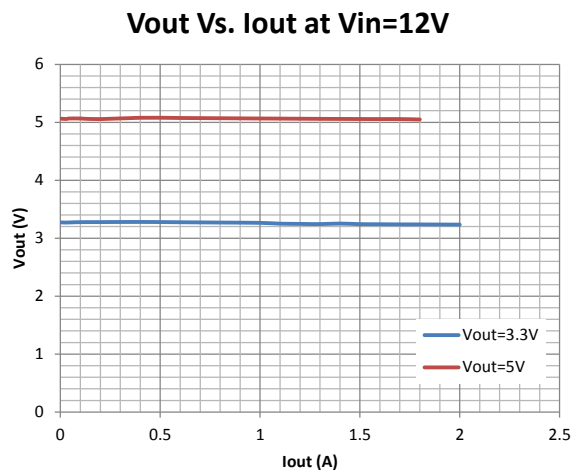

Switching waveform Vin=24V, Out=5V/1A
(CH1=Vin, CH2=Vout, CH3=SW, CH4=Isw)

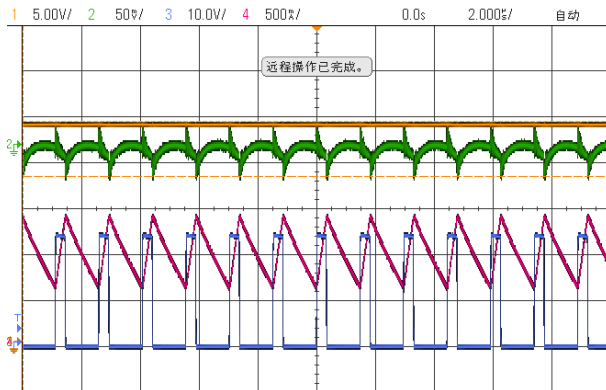

Load Transient Response
Vin=24V, Vout=5V, Iout=0.5 - 1A
(CH2=Vout, CH4=Iload)

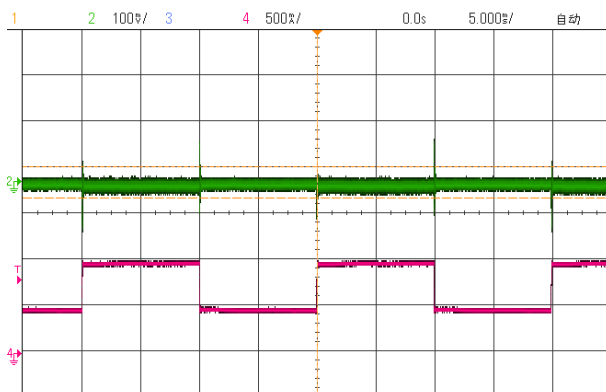

Switching waveform Vin=36V, Out=5V/1A
(CH1=Vin, CH2=Vout, CH3=SW, CH4=Isw)

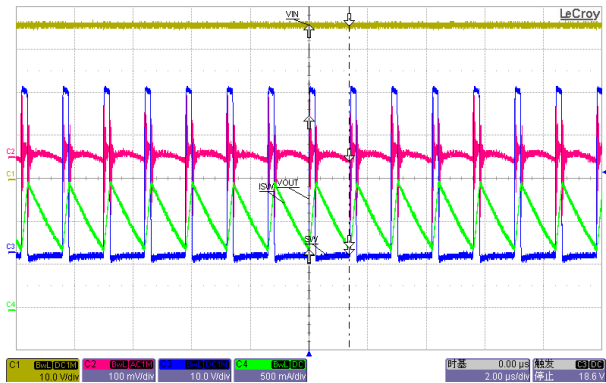

Power Up Response
Vin=24V, Vout=5V, Iout=0.5A
(CH1=Vin, CH2=Vout, CH3=SW, CH4=Isw)

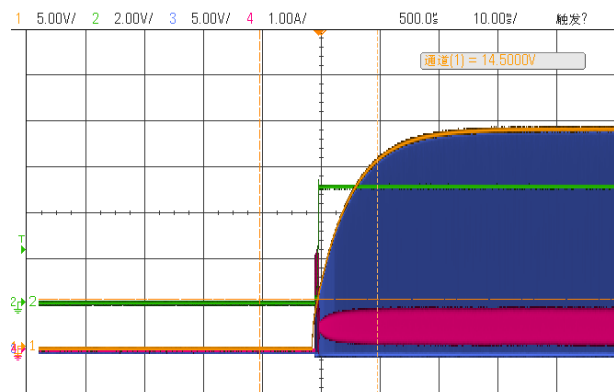

FUNCTIONAL DESCRIPTIONS

Loop Operation

The LC2327 is a wide input range, high-efficiency, DC-to-DC step-down switching regulator, capable of delivering up to 0.6A of output current, integrated with a 400mΩ MOSFET, with external schottky diode. It uses a PWM current-mode control scheme. An error amplifier integrates error between the FB signal and the internal reference voltage. The output of the integrator is then compared to the sum of a current-sense signal and the slope compensation ramp. This operation generates a PWM signal that modulates the duty cycle of the power MOSFETs to achieve regulation for output voltage.

Current Limit

There is a cycle-by-cycle current limit on the high-side MOSFET of 2.2A (typ.) when $V_{in} \leq 24V$. The current limit linearly decreases when V_{in} increase above 24V, and finally becomes 1.2A (typ.) at $V_{in}=36V$. When the current flowing out of SW exceeds this limit, the high-side MOSFET turns off and the external schottky diode rectifier turns on. Unlike the traditional method of current limiting by limiting the voltage at the internal compensation node, which usually has large variation due to duty cycle variance, this type of peak current limiting scheme provides a relatively more accurate limit for output current, thereby lowering the requirements for system design.

Light Load Operation

Traditionally, a fixed current mode constant frequency PWM DC-DC regulator always switches even when the output load is small. When energy is shuffling back and forth through the power MOSFETs, power is lost due to the finite RDSOns of the MOSFETs and parasitic capacitances. At light load, this loss is prominent and efficiency is therefore very low. LC2327 employs a proprietary control scheme that improves efficiency in this situation by enabling the device into a power save mode during light load, thereby extending the range of high efficiency operation.

COMPONENT SELECTION

When setting up the LC2327 for different output voltage, please use following recommended component value for the best performance.

V_{OUT} (V)	C_{OUT} (μ F)	L (μ H)
8	22	15 - 22
5	22	10 - 15
3.3	22	6.8 - 10

THERMAL CONSIDERATION

LC2327 is high efficiency Buck converter, which means it consumes very few power when converting the high voltage to low voltage. However, when output power is very large, like 5V/1.5A, the output power is as high as 7.5W, a heat dissipation path is strongly recommended to be routed on PCB. LC2327 is in SOT23-6 package. The heat is conducted out via Pin 2 (GND), so the heat dissipation route on PCB should be connected to the Pin 2 of the chip.

PACKAGE OUTLINE

Package	SOT23-6	Devices per reel	3000	Unit	mm
Package specification:					
<p>The drawing shows the SOT23-6 package with the following dimensions:</p> <ul style="list-style-type: none"> Top view: Total width 2.9 ± 0.2 mm, distance between pins 4 and 5 1.9 ± 0.2 mm, pin pitch 0.95 mm. Side view: Total height 2.8 ± 0.3 mm, distance from top surface to pin 4 1.6 ± 0.2 mm, distance from top surface to pin 2 0.4 ± 0.1 mm. Bottom view: Pin 2 height 0.15 ± 0.05 mm, pin 2 length 0.2 mm MIN. 					